

GAS PURIFICATION & **CONTROL SYSTEMS**



www.pcianalytics.in

- Gas Purification Systems
for GC/AAs/ICP/TOC/LC-MS/Lab Equipment
- Cylinder Regulators
- Manifold Systems
- Cylinder Trolleys
- LPG Gas Handling Systems
- Point of use / Control panel

Gas Purification & Control Systems



ISO 9001:2000

Gas Purification & Control Panel

Salient Features :

- Deliver Ultra High Pure (UHP) Grade Gases
- Compact Design, Wall Mounted, Powder Coated
- Filters are easily detachable
- Suitable for 10kg/cm² inlet pressure & 7 kg/cm² outlet pressure
- Panel for LC-MS-MS & other applications are also available

Benefits for GC :

- Reduce baseline noise, drift problems, etc.
- Increase column life, GC detectors & reduces flame problems
- Improve reproducibility
- Save costly gases through toggle valves & gas distribution panel.



Model - GPP-01



Model - GPP-01

Double Stage Cylinder Regulator

- Two types of Cylinder Regulators available Brass Chrome Plated body with SS diaphragm and SS body with SS diaphragm.
- Regulator consist of inlet & outlet pressure gauges. Inlet pressure gauge shows the total pressure of cylinder and outlet pressure gauge shows regulated pressure.
- High pressure piston type Regulator & Regulators for corrosive gases like Ammonia, Chlorine, etc. are also available.
- Inlet pressure range: 0 - 240 kg/cm²
- Outlet pressure range: 0 - 14 kg/cm² diaphragm type
- Outlet pressure range: 0 - 40, 0 - 70, 0 - 100 kg/cm² piston type



Digital Automatic (Low Pressure)



Mechanical Automatic (High Pressure)

Electronic (Digital) / Mechanical Automatic Gas Changeover / Manifold System

Two types of change over system available, low pressure electronic (digital) automatic change over & high pressure mechanical automatic change over. We can connect two cylinders of same gases where cut off pressure or cylinder change over pressure can be programmed in digital automatic & cylinder automatically changes from line 1 to line 2 as per program, where as in mechanical automatic, the cut off pressure is done by differential pressure regulators and the change over of the cylinder is done as per differential pressure set.

Inline Micron Filters

Inline Micron Filters are used to remove dust particles from respective gases. Micron filter (SS body) consist of SS disc (Mesh) of 5 μ - 10 μ .

Gas purification panel removes impurities which are in vapours (gases) form. Cylinders being M.S. body has the tendency to illute dust particles, these particles may come in the line and may go to gas chromatograph. To avoid this particles micron filters are very essential.





Manifold Block (3 & more Cylinder)



Manifold Block (Two Cylinder)



Flexible Pigtail

High Pressure Gas Manifold System (Manifold)

Gas manifold is used to connect two or more cylinders of same type with common cylinder regulator. The advantage of using manifold is to change from empty cylinder to filled cylinder without disconnecting the gas. MOC is brass chrome plated with ISI mark valve. It also consists of high pressure flexible pigtail of 1 meter long with 1/4" teflon tubing with SS brading with mounting bracket. The manifold are also available for two or more cylinders.

Tubing / Casing Capping

Tubing are available in different sizes like 1/2", 1/4", 1/8", 1/16" which are available in copper, S.S., teflon, nylon. Size of the tubing are decided on required flow & pressure.

Casing capping are used to cover the above tubing & to maintain the esthetic look.

Three types casing capping available, M.S. powder coated, alluminium powder coated & PVC casing capping.

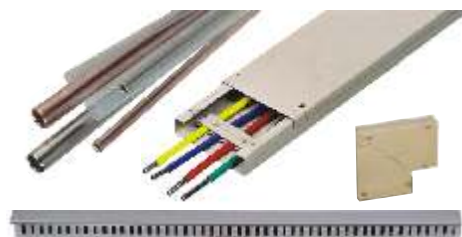

Gas Distribution Panel

Gas distribution panel is used when there is more than one Gas Chromatograph. It helps to controlled the flow & pressure of different gases for different GC's. Gas distribution panels are available in three different types. One is with pressure gauge (to indicate pressure), pressure regulator (to control pressure), ON/OFF valve (to isolate). Second with pressure gauge and ON/OFF valve. Third is with only ON/OFF valve.

Cylinder Trolley & Cylinder Mounting Bracket

- Cylinder mounting brackets are used to mount the cylinder on wall to avoid down fall of cylinder. There are two types of cylinder mounting brackets available one with wall mounting and another with floor mounting.
- Cylinder trolleys are used for smooth transportation of cylinders from one place to another place. Specially designed (Four Wheel) for easier handling of cylinder.



Cylinder Trolley

Cylinder Mounting Bracket



Gas Selector Box

Gas Selector Box is used for the selection between two gases of different types.

Two types of gas selector box available one with selector valve, pressure gauge & toggle valve, another with only two toggle valve.

Technical Specifications:

| APPLICATION | FILTER TYPE | MAX. INLET IMPURITY LEVEL | MAX. OUTLET IMPURITY LEVEL | LENGTH End to End | CAPACITY |
|----------------------|-----------------------------|---------------------------|----------------------------|-------------------|----------|
| Moisture Removal | Silicagel / Molecular Sieve | 20 ppm | < 3 ppm | 10" | 210 CC |
| Hydro Carbon Removal | Activated Charcoal / Carbon | 10 ppm | < 2 ppm | 10" | 210 CC |
| Oxygen Removal | De-Oxo Chemical catalyst | 10 ppm | < 2 ppm | 8" | 125 CC |
| Particle Removal | Micron Filter | 25 μ | < 0.5 μ | 2" | — |

- Pressure Regulators : Maximum inlet pressure 10 kg / cm²
 Optional pressure range 0-7 kg / cm² with Neopren Rubber Diaphragm / SS Diaphragm
- Size of Pannel : 420W x 600H x 87D in mm (Model GPP-01)
- Net weight : 14 kg. (Model GPP-01)
- Toggle valve : On / off type
- Pressure Guages : 0- 10 kg / cm² Pannel mounting
- Pannel Body : Powder coated wall mounted design with optional safety frame & fully S.S. body
- Tubings : S.S. / Copper / Nylon with colour coated sleeves
- Optional : Bigger size of oxytrap for LC-MS-MS & indicating oxytrap for GC MS

Installation Diagram

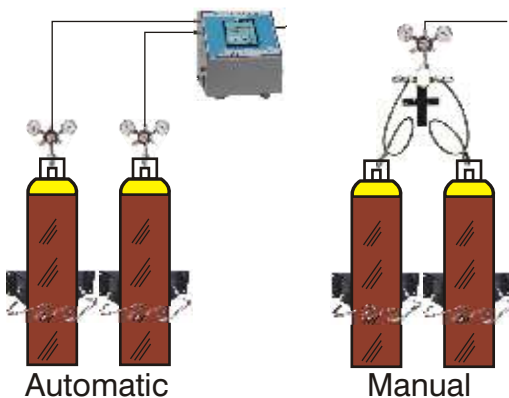
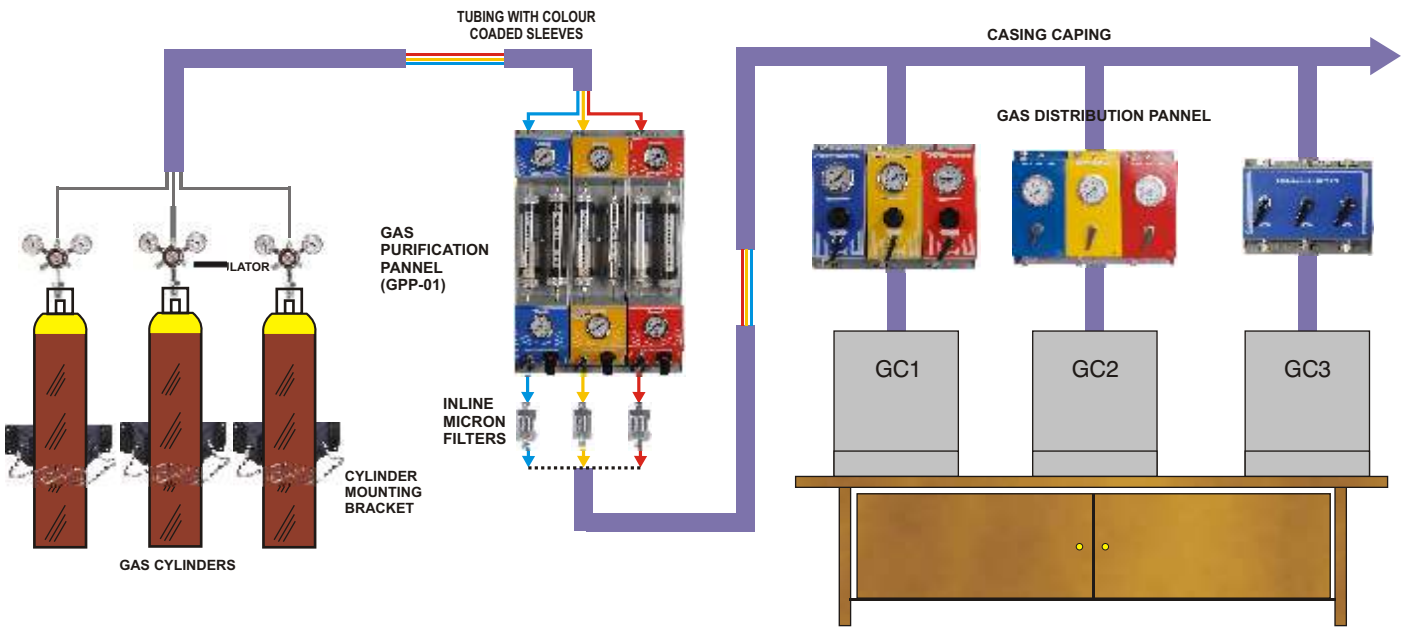

Gas Manifold System (Manual/Automatic)

- In ICP or ICP-MS the consumption of Argon Cylinders is high so one has to change the cylinder at regular intervals.
- To avoid the changing of the cylinder we manufacture gas manifold system where one can connect multiple cylinder at a time and can change from empty cylinder to filled cylinder manually or automatically by using gas manifold system

AAS Accessories



Cylinder Regulator- Acetylene/N₂O/Argon

- Cylinder Regulator for the controlling of outlet pressure of cylinder for Acetylene & Nitrous oxide & Argon gas
- M. O. C. : Brass Chromplated Body or SS Body with SS Diaphragm
- Pre heater for Nitrous oxide gas

Fume Hood & Blower

- AAs deliver fumes which needs to be exhaust outside the lab which is to be ventilated by fume hood with exhaust fan or blower. M. O. C. : SS Body
- For AAs: Blower: SS body, 1/4 HP, 1800 RPM
- For ICP: Blower: SS body, 1/2 HP, 2800 RPM

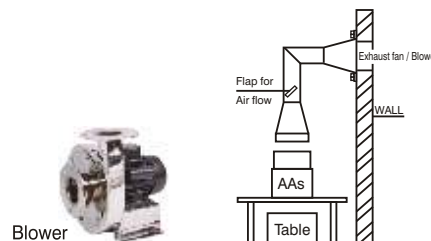

Air Compressor / Gas Control Box for Air/Acetylene/N₂O

- AAs requires compressed Air supply of high flow rate which can be supplied by Air compressor which consist of 20 liter storage tank, pressure switch, safety valve, gauge & outlet valve etc.
- Oilfree as well as Noiseless (Oil based) compressor are also available
- Compressor being at high flow & pressure has to be controlled before going to the AAs with the help of Gas Control Box.
- Gas Control Box can be used for Acetylene & N₂O gas also.



Air / Moisture Filter (Manual/Auto)

- Moisture free Air is must for AAS. Filter of 5 μ & 0.1 μ which is to be attached after air compressor for the removal of Moisture, oil, dust and mist particles.
- There are two types of Air Filters available, manual drain & automatic drain.

Gas Purification / Control System

- Gas purification panel is used to remove the vapours impurities like Moisture, CO, CO₂, Hydrocarbon from N₂O, Argon & Acetylene
- Gas purification for AAs & ICP-MS is optional one can also used gas distribution panel instead of gas purification panel.



Installation Diagram for AAs

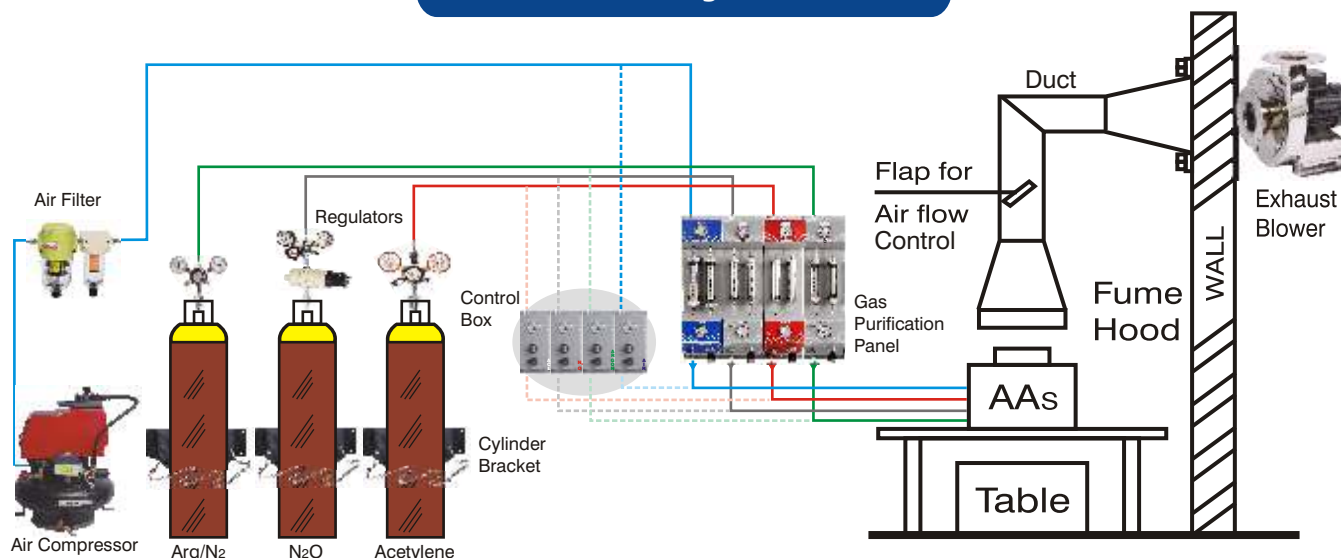

ICP/ICP-MS Accessories

Double Stage Cylinder Regulator



- Two types of Cylinder Regulators available Brass Chrome Plated body with SS diaphragm and SS body with SS diaphragm.
- Regulator consist of inlet & outlet pressure gauges. Inlet pressure gauge shows the total pressure of cylinder and outlet pressure gauge shows regulated pressure.
- High pressure piston type Regulator & Regulators for corrosive gases like Ammonia, Chlorine, etc. are also available.
- Inlet pressure range: 0 - 240 kg/cm²
- Outlet pressure range: 0 - 14 kg/cm² diaphragm type
- Outlet pressure range: 0 - 40, 0 - 70, 0 - 100 kg/cm² piston type

Tubing / Casing Capping

Tubing are available in different sizes like 1/2", 1/4", 1/16" which are available in copper, S.S., teflon, nylon. Size of the tubing are decided on required flow & pressure.

Casing capping are used to cover the above tubing & to maintain the esthetic look.

Three types casing capping available, M.S. powder coated, alluminium powder coated & PVC casing capping.

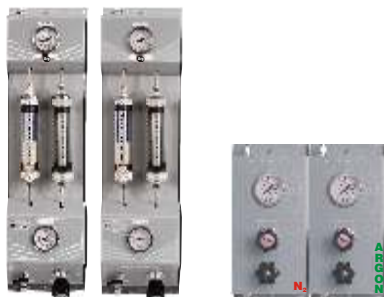

Gas Purification / Control System

- Gas purification panel is used to remove the vapours impurities like Moisture, CO, CO₂, Hydrocarbon from N₂ & Argon.
- Gas purification for AAs & ICP-MS is optional one can also used gas distribution panel instead of gas purification panel.

Fume Hood & Blower

- AAs deliver fumes which needs to be exhaust outside the lab which is to be ventilated by fume hood with exhaust fan or blower. M. O. C. : SS Body
- For AAs: Blower: SS body, 1/4 HP, 1800 RPM
- For ICP: Blower: SS body, 1/2 HP, 2800 RPM

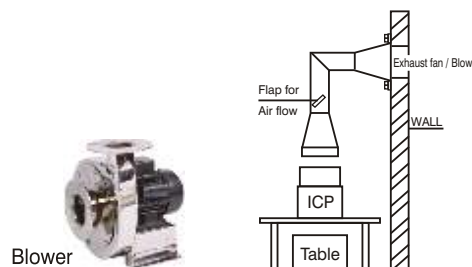

Installation Diagram

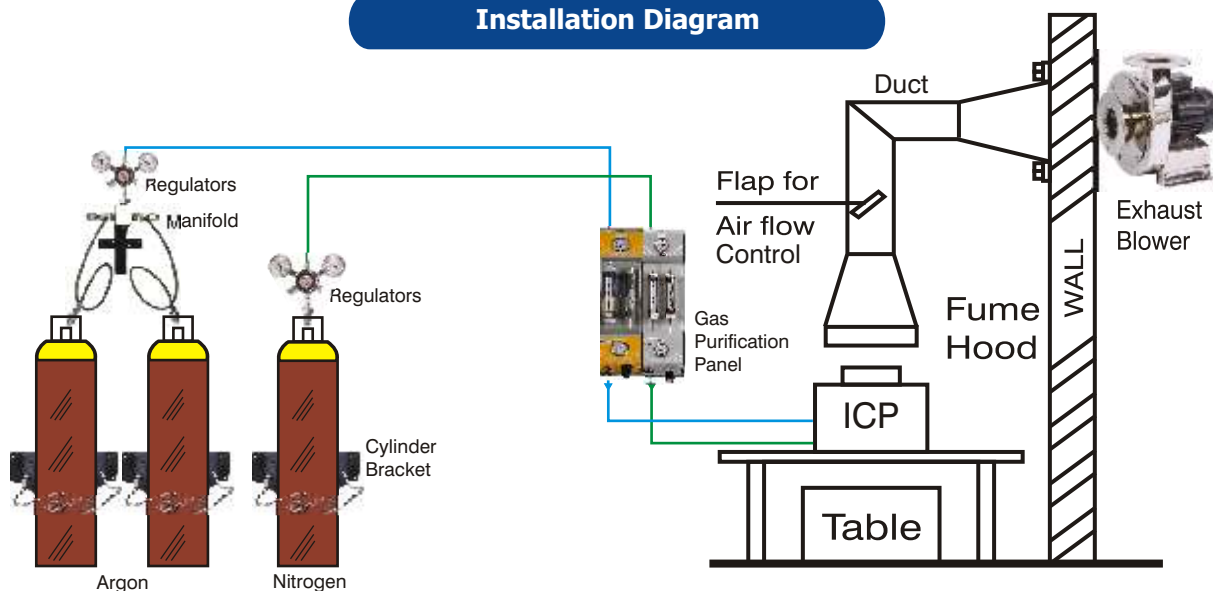

LPG Gas Line Accessories

Manifold Block / Manifold System



Pigtail / Cylinder Adaptor / Pressure Gauge with Regulator



Isolation / Control Valve / Burner



Installation Diagram

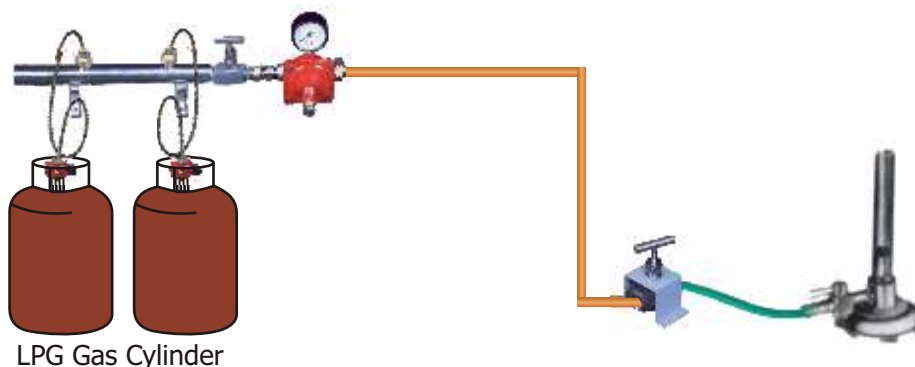

LPG Gas Cylinder

Rotameter

Rotameter is used to measure flow for different gases.

Body: Acrylic body or glass body with aluminium encased with appropriate float as per flow and gas requirement.

Size: Standard size available is 6" - 8" length with needle valve

Inlet & outlet connection: Back side with 1/4", 1/8", hose connection with panel mounting, table mounting stand are also available.

Range: Any range in LPM or ml/min or LPH



Control Box with Rotameter



Regulator & point of view

Brass Chrome Plated Regulator

Regulator

Double / Single Stage, Brass CW614 specially cleaned with SS316 diaphragm with PCTFE seat sealing

- Inlet pressure 230 bar
- Outlet pressure 1-14 bar



FMD 230-14
FMD 232-14



EMD 400-06

Mini Regulator with Gauge & Shut-off Valve

Point of use regulator Single Stage, Brass CW614 / SS 316 Body specially cleaned (Line Regulator for laboratory furniture) with pressure gauge & shut-off valve

- Inlet pressure 0-40 bar
- Outlet pressure 0.5-10.5 bar

Mini Regulator with Gauge

Point of use regulator Single Stage, Brass CW614 / SS316 Body specially cleaned (Line Regulator for laboratory furniture) with pressure gauge

- Inlet pressure 0-40 bar
- Outlet pressure 0.5-10.5 bar



EMD 400-01



BMD 500-35 DS

Auto Changeover

Fully automatic gas change over system for 2 cylinder Single Stage with independent adjustable pressure regulator levels, Brass CW614 / SS316 specially cleaned with SS316L diaphragm with PCTFE seat sealing without cylinder connection with Purge Valve & Shut-off Valve

- Inlet pressure 230 bar
- Outlet pressure MSD 0.2-10.5 bar

Gas Piping Utility Project

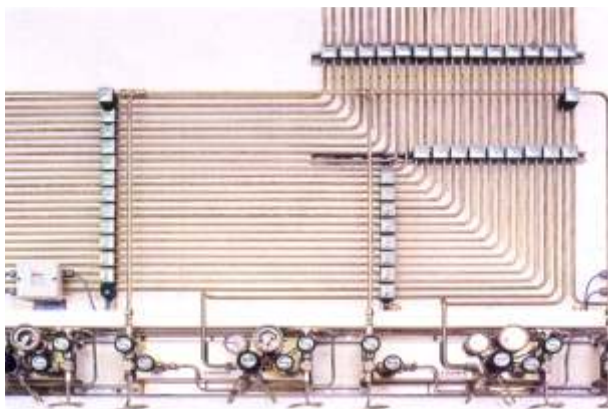

Gas Pipe Routing

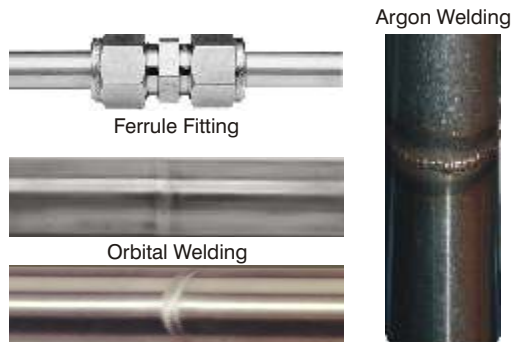

Types of Welding



Single/Two Way Valve & Flexible Hoss



Clamps & Supports



Ball / Gate / Butterfly Valves



Compression/Socket Fittings

PCI Analytics Pvt. Ltd.

3/14, Bhandup Ind. Estate, Tel. : +91 (22) 4094 6946 / 6755 1300 / 2596 3997
 Pannalal Compd., Fax : +91 (22) 6755 0863
 L.B.S. Marg, Bhandup (W), E-mail : info@pciss.com / pcianalytics@yahoo.com
 Mumbai - 400 078. India URL : www.pciss.com / www.pcianalytics.in

