

7900

ROMAN BLIND
SYSTEM

7900



G-RAIL[®]
ALUMINIUM RAIL

> *by Goelst*



Contained within the cassette headrail, the spiralled cord mechanisms provide smooth lifting of the chain operated Roman blind system. By adjusting the lifting cords, several decorative effects can be achieved.

Standard colour: White

7900 > The innov cassette Ro

ROMAN BLIND
SYSTEM

7900



Installation

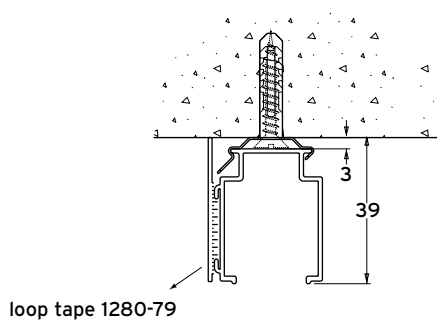

ceiling mounting with 7950

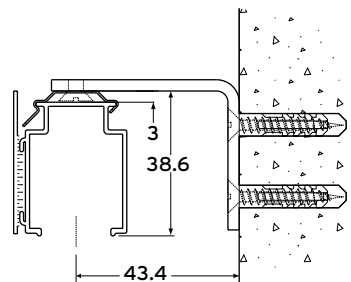

wall mounting with 2015-05

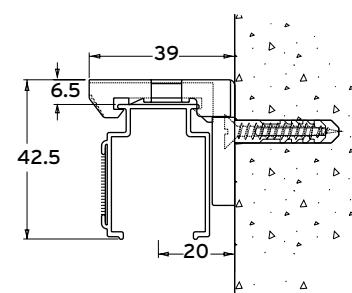

wall mounting with 7951-C

Curtain hanging examples

Roman Blind (soft fold)

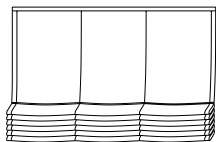

Roman Blind (hard fold)

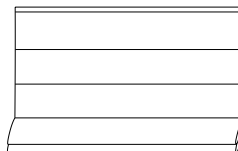

Greek Blind

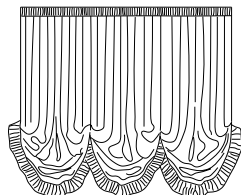

Austrian Blind

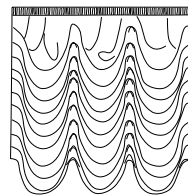

Festoon Blind

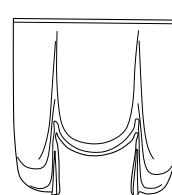



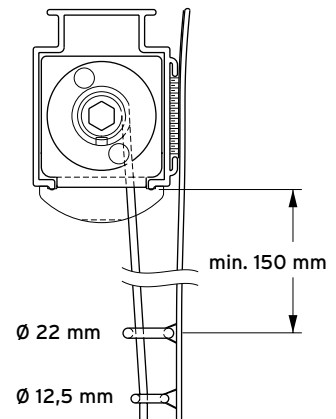

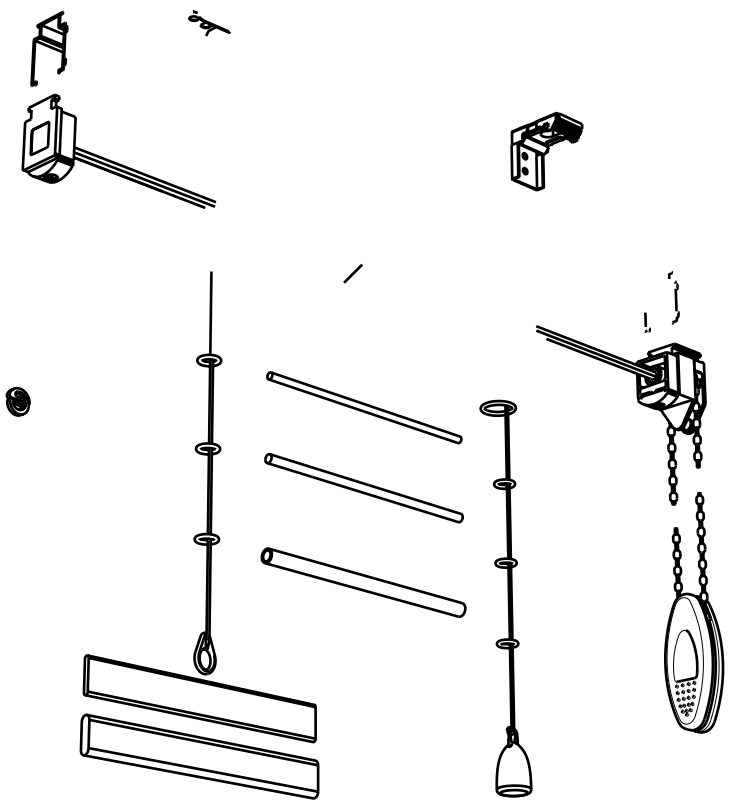



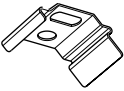
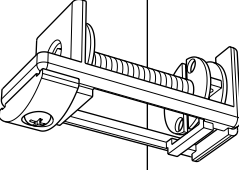
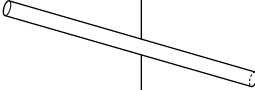
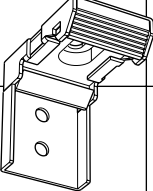
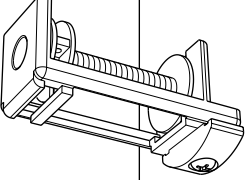
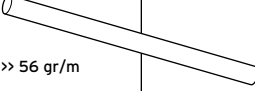
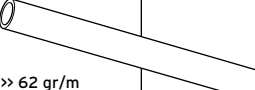
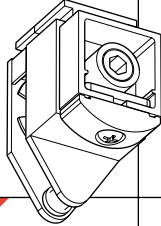
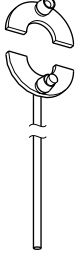
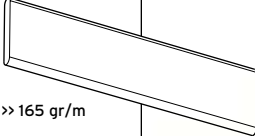
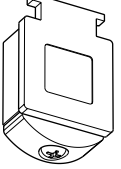
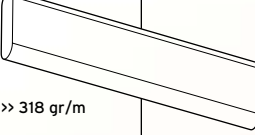
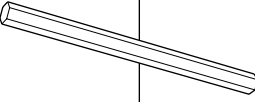

Belgian Blind

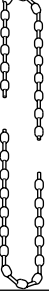
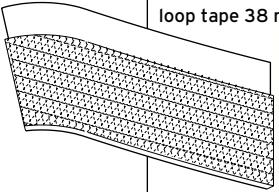

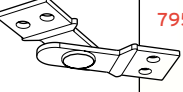

Components

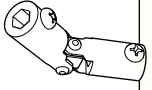
Product design and specification changes reserved.

| FIXING BRACKETS | | | | | |
|---|--|---|--|---|--|
|  | 7950 ceiling bracket can be comb. with 2015 colours: N - W |  | 7940-R winding spindle right hand (beige) |  | 7499-4-PH-4 plexiglass insert 4 mm x 4 m |
|  | 7951-C wall / ceiling bracket |  | 7940-L winding spindle left hand (black) |  | 7491-5-N alum. round bar 5 mm x 6 m >> 56 gr/m |
| | | | |  | 7492-08-N alum. round tube 8 x 6 mm x 6 m >> 62 gr/m |
| ACCESSORIES | | | | | |
|  | 7930 chain control |  | 7921-550-10 2x cord adapter (7922) + 1 mm cord 550 cm |  | 7490-203R bottom bar 20 x 3 mm x 6 m colours: N - W >> 165 gr/m |
|  | 7953 end cap | | |  | 7490-206R bottom bar 20 x 6 mm x 6 m colours: N - W >> 318 gr/m |
| | |  | 7911-SN-3.05 hexagonal drive shaft 3,05 m |  | 7981-10 S-hook |
|  | 7932 endless chain 100 cm 150 cm 200 cm 250 cm 300 cm 400 cm |  | 1280-79 loop tape 38 mm provides fabric upstand to ceiling level |  | 7924-20 quick release cord ring (clear) for 1 mm cord |
| | | | |  | 7980-128-10 transparent ring 12,5 x 8 mm |
|  | 1203-11 chain weight |  | 7952 adjustable profile connector |  | 7980-2217-10 transparent ring 22 x 17 mm |
| | |  | 7925 universal connector |  | 7995-KG Bell weight white |

ROMAN BLIND SYSTEM

7900

N = natural
W = white

 = standard item

G-RAIL®

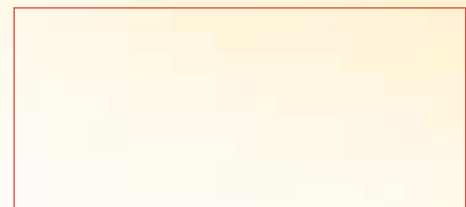
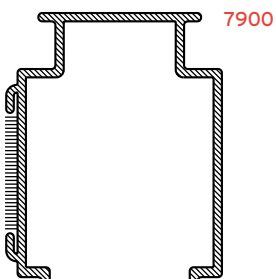

Space for dealer address

11/2002